



HITACHI 505E

analog/hybrid computer



TOTALLY NEW AGEIN

The Hitachi 505E is a totally new state-of-the-art computer designed to aid in solving today's sophisticated problems. Despite its desk-top size, complete integrated hybrid system capability has become available along with unbelievably low-cost servo-set potentiometers, automatic output selection unique digital logic components, and problem board. This 100-volt, all solid state machine provides the widest variety of choice both for components and control structures. Choose for digital logic circuits, choose for fast switching electronic mode control, choice in servoset potentiometers, and even choice of complete integrated hybrid computation system capability. HITACHI's over 18 years' experience in the analog computer field stands behind the 505E which is provided with the world's most versatile and flexible mechanical construction throughout.

(Specifications are subject to change without notice)

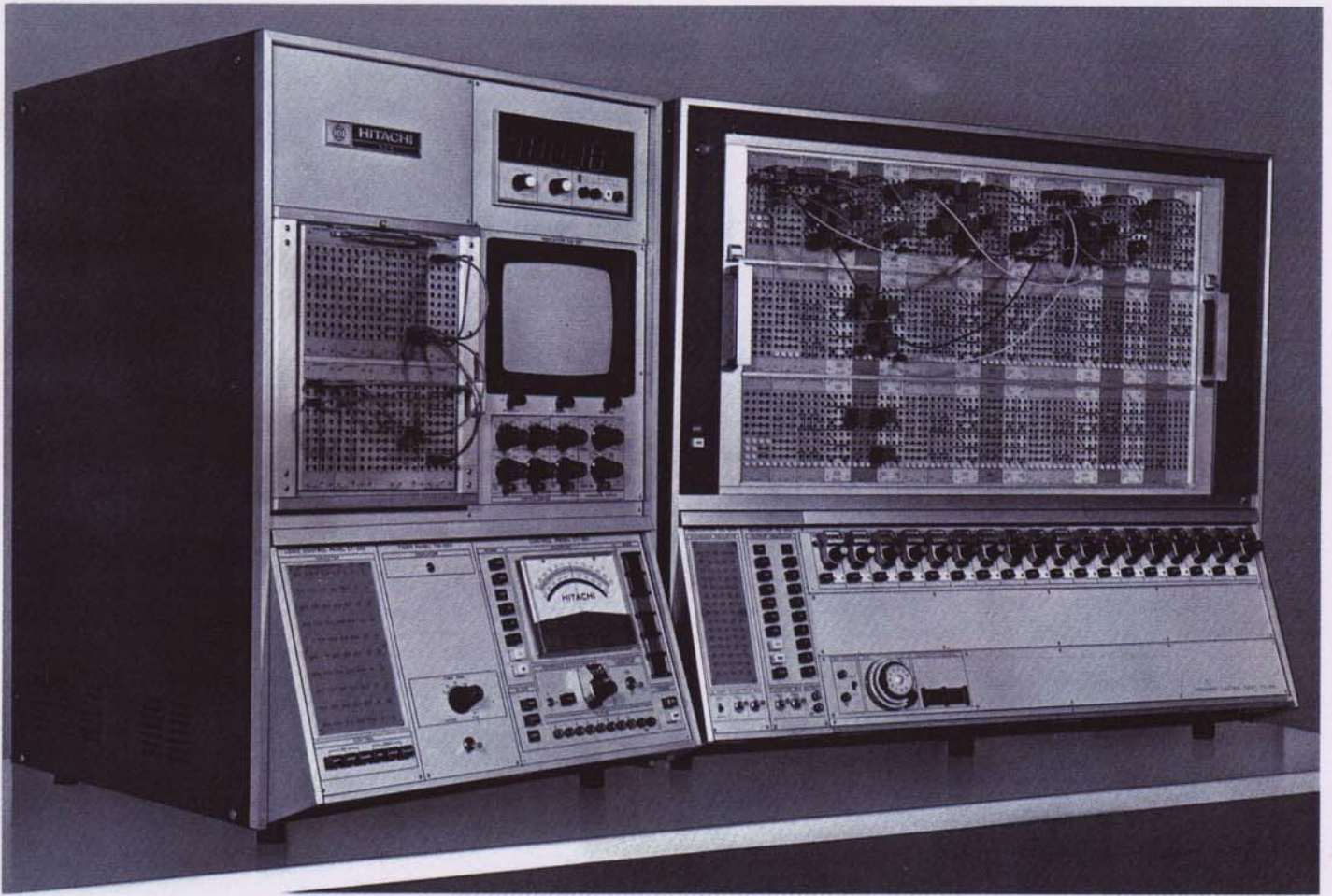

CONTENTS

Page 4	CONVENIENCE IN HYBRID COMPUTATION
Page 6	OUTSTANDING FEATURES
Page 10	CONVENIENCE IN OPERATION
Page 12	CONVENIENCE IN MAINTENANCE
Page 13	DESCRIPTIONS OF ANALOG COMPONENTS
Page 21	DISPLAY EQUIPMENT
Page 22	DIGITAL LOGIC PACKAGE
Page 24	ACCESSORIES
Page 25	CONFIGURATIONS AND EXPANDABILITY

CONVENIENCE IN HYBRID COMPUTATION

The HITACHI 505E offers today's scientist a more practical approach to hybrid computation, with more economic and faster problem solutions. The analog console is fully prewired for expanding the computer to a complete integrated hybrid computation system. Feasibility to accept hybrid control signals for automatic amplifier readout, automatic addressing and automatic setting of servo-set potentiometers, A-D, D-A lines, Ci Co signals, program interrupts, clocks, and mode control lines—all of these networks and structures are offered by an extensive hybrid computation system.

SERVO-SET POTENTIOMETERS

The HITACHI 505E accommodates either 108 manual potentiometers or 72 servo-set potentiometers and 36 manual potentiometers. The basic servo-set control structure requires only exceptionally low-cost addition.

The servo-set system of the HITACHI 505E consists of the Servo-set Control Panel (CT-253A), Servo-set Potentiometer Patch Unit (SP-151), and Address Selector (SL-252S).

The Servo-set Control Panel (CT-253A) contains a servo amplifier, servo controller, and matrix inputs of an amplifier addressing and coefficient setup which may be terminated to the hybrid linkage.

A POT-SET button (green, self-lighting) on the panel CT-251 automatically lights when the patchboard is engaged, allowing the Address Selector (SL-252S) to select a servoset potentiometer.

A HYBRID button (red, self-lighting) located adjacent to the SET START button controls hybrid operation. As long as the HYBRID button is ON, the HITACHI 505E readily accepts addressing and coefficient setup signals from the hybrid linkage. In standard configuration, the reference potentiometer (0.1% linearity) on the Control Panel (CT-251) is used for generating coefficient setup input to the servo amplifier. A high-accuracy type reference potentiometer (0.0075% linearity) is optionally available.

Every six servo-set potentiometers are grouped in the Servo-set Potentiometer Patch Unit (SP-151), individually provided with a high-performance servo induction motor. The SP-151 is mounted directly behind the patchboard so that it considerably reduces phase error and obtains accurate, reliable computer solutions.

The Potentiometer Patch Unit, PT-151, may be replaced by the SP-151 without console modification. Since the computer is preliminarily designed to fully accept either servo potentiometers or manual potentiometers, the user has a variety of choices when purchasing the machine.

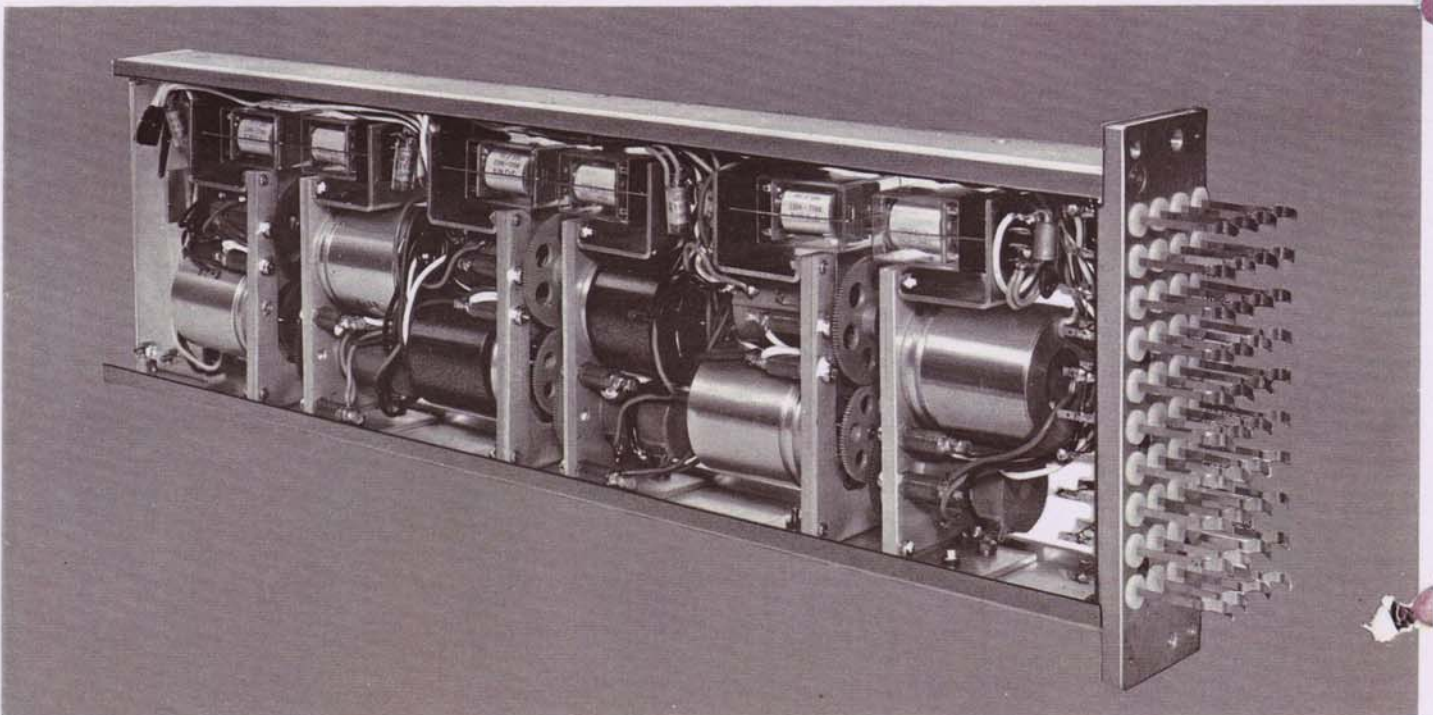

HYBRID DIAGRAM

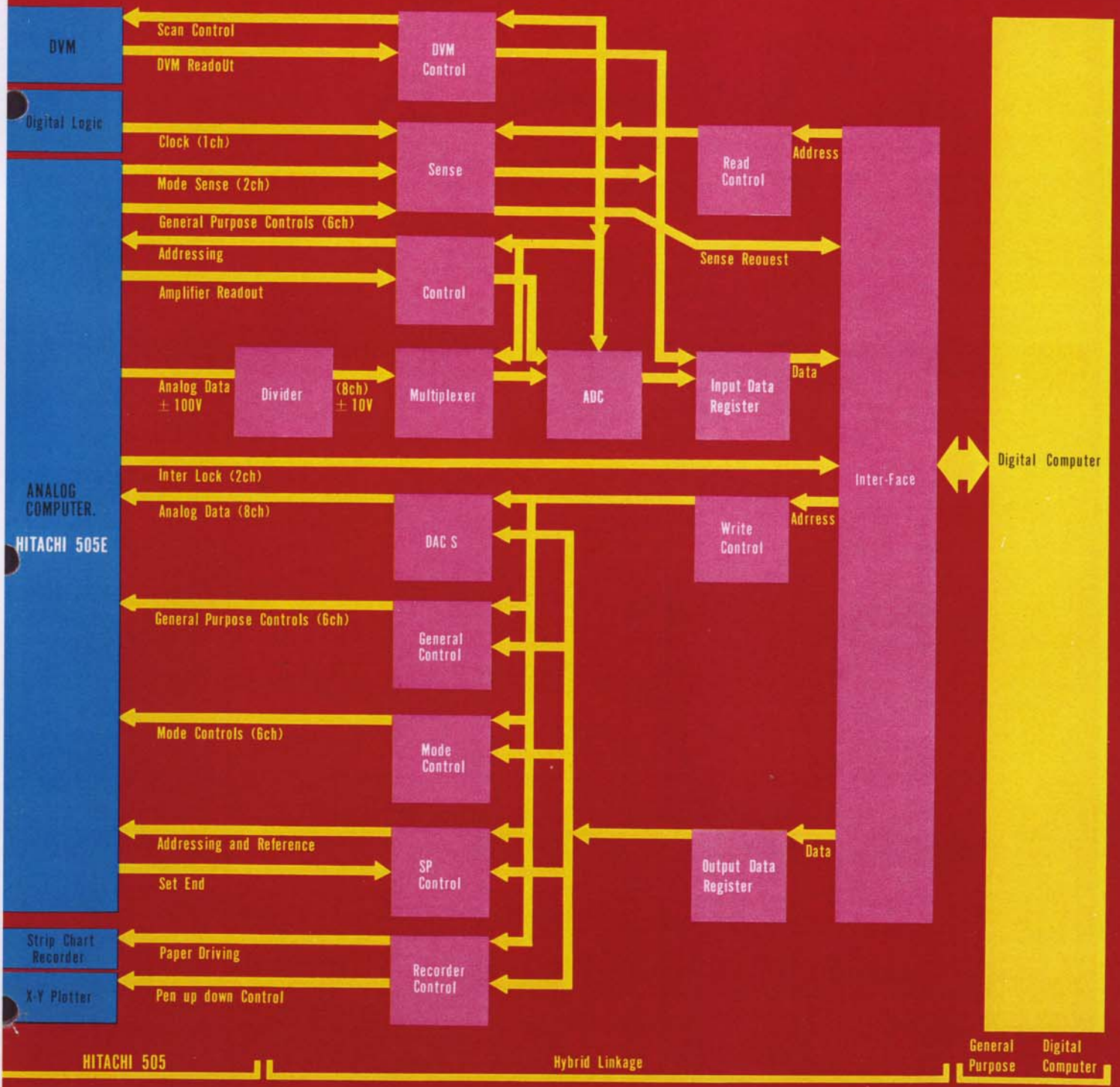

1 ALL SOLID STATE DESIGN

Hitachi 505E's complete utilization of solid state materials throughout has resulted in exceptionally high performance and reliability among 100V desk-top analog computers. Most of these solid state materials are replaced by silicon transistors and diodes which have less temperature coefficient in normal atmosphere and give the programmer stabler computer solutions in minimum operation time.

2 HIGH-PERFORMANCE 100V OPERATIONAL AMPLIFIER

As a result, a new Hitachi 505E operational amplifier with $\pm 100V/25mA$ output has improved computing accuracy and signal-to-noise ratio, and has provided more accurate nonlinear components as well. Consequently, despite its desk-top size, the Hitachi 505E demonstrates computing accuracy similar to that of larger, more expensive equipment.

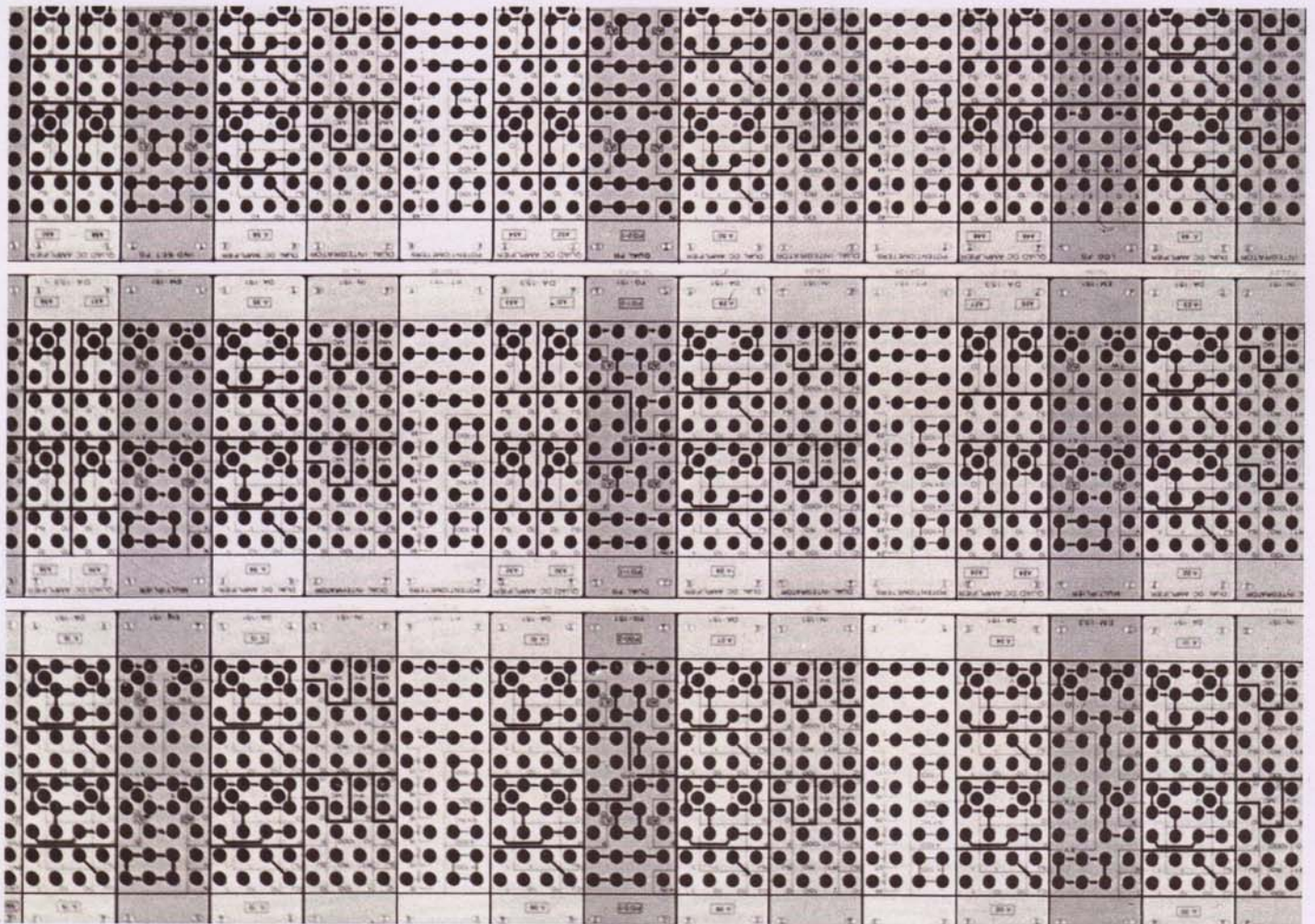

3 COLOR-CODED, SHIELDED PATCH PANEL

Among desk-top analog computers, Hitachi 505E is the only machine available equipped with a Color-Coded, Shielded Patch Panel. Having different colors for each unit, the component layout, planned for maximum use of low-capacity bottle plugs, not only reduces lead length but simplifies wiring. An all-metal patch board reduces computer noise. Removable unit-by-unit panel structure eases component replacement and/or expansion. The colors used are subdued and elaborately selected from the viewpoint of human factor engineering, the marking on the patch panel carefully designed to provide easy identification of each component and its hole function (e.g. numbering and lettering to the upper left of the hole is not hidden behind the fingers or pin-holders of patch cords while patching; printed by color between two holes shows that a bottle plug connection is required for appropriate programs). Shielding is extended to the digital logic patch panel.

4 THREE-CYCLE, HIGH-SPEED REPETITIVE OPERATION

Among desk-top analog computers, the Hitachi 505E is, once again, the only computer available that features three-cycle, high-speed repetitive operation facilities. Hitachi 505E's unique, three-channel monostable timer provides three mode control signals with an independent time variable from 10s to 1ms each. In fact, in optimization problems, for instance, 3-cycle repetitive operation among RESET, COMPUTE and HOLD, is a powerful operational means of reducing extra amplifiers and integrators which might be indispensable in usual 2-cycle repetitive operation. The timer may be used for other purposes, too, because of patchable control inputs and outputs available on both the analog and digital logic problem boards (i.e. CLEAR, RUN, STOP).

5 EXTRA MODE, ALL-RESET

Most analog computer users might not be familiar with the term ALL-RESET. May Hitachi computer engineers assume that some sort of mode to initialize all integrators patched for various modes are needed in your research by now? That is the mode, ALL-RESET. A patchable independent mode for integrators is now common to almost every analog computer in the field. However, as scientific and industrial problems become more sophisticated on computer analysis, the simultaneous control mode which gives priority to individual patched mode is often needed. The mode, ALL-RESET, helps the programmer to reduce complicated logical patching and to save time.

6 SELF-CONTROL SYSTEM FOR CONSOLE TEMPERATURE

Despite its desk-top size, the Hitachi 505 is equipped with a self-control temperature system that maintains console temperature at $95^{\circ}\text{F} \pm 2^{\circ}\text{F}$ and protects analog components, including amplifiers, integrators, multipliers, and so on from outside temperature. So, the Hitachi 505E does not require a bulky air conditioner and may be installed under normal living conditions (32°F to 95°F) for normal computer operation. Such a feature improves solution reliability and yields higher computer performance with less module adjustment.

7 EXPANDABILITY FROM BASIC CONFIGURATIONS TO 124 AMPLIFIERS

Because of its unified component arrangement, the Hitachi 505E is simply expandable from basic configurations with 10 operational amplifiers, 4 integrator networks, 18 potentiometers, etc. up to 124 operational amplifiers and various combinations of nonlinear components without a single soldering operation. The computer covers a wide range of field requirements from student training to today's advanced scientific use with various options and alternatives available to fit the customer's budget.

OUTSTANDING FEATURES

8 VERSATILE AND FLEXIBLE INTEGRATOR PERFORMANCE

Hitachi 505E integrator network provides:

- Patchable time scale among 1s, 0.1s, 0.01s, and 0.001s.
- Patchable mode control.
- EMC options with no console modification.
- Direct mode control from digital logic problem board without voltage level converters or buffer amplifiers.
- Polyethylene capacitors with minimum absorbent coefficient.
- Patchable track store unit.
- Patchable electronic switch available at EMC integrators.

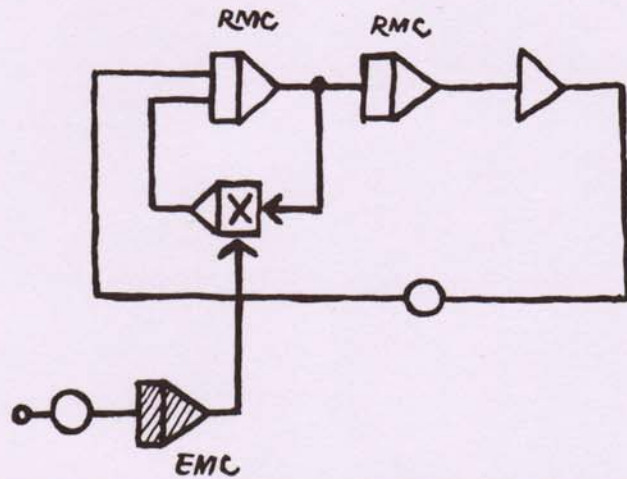

9 FOUR CHANNELS BUILT-IN OSCILLOSCOPE with ELECTRONIC SCALE

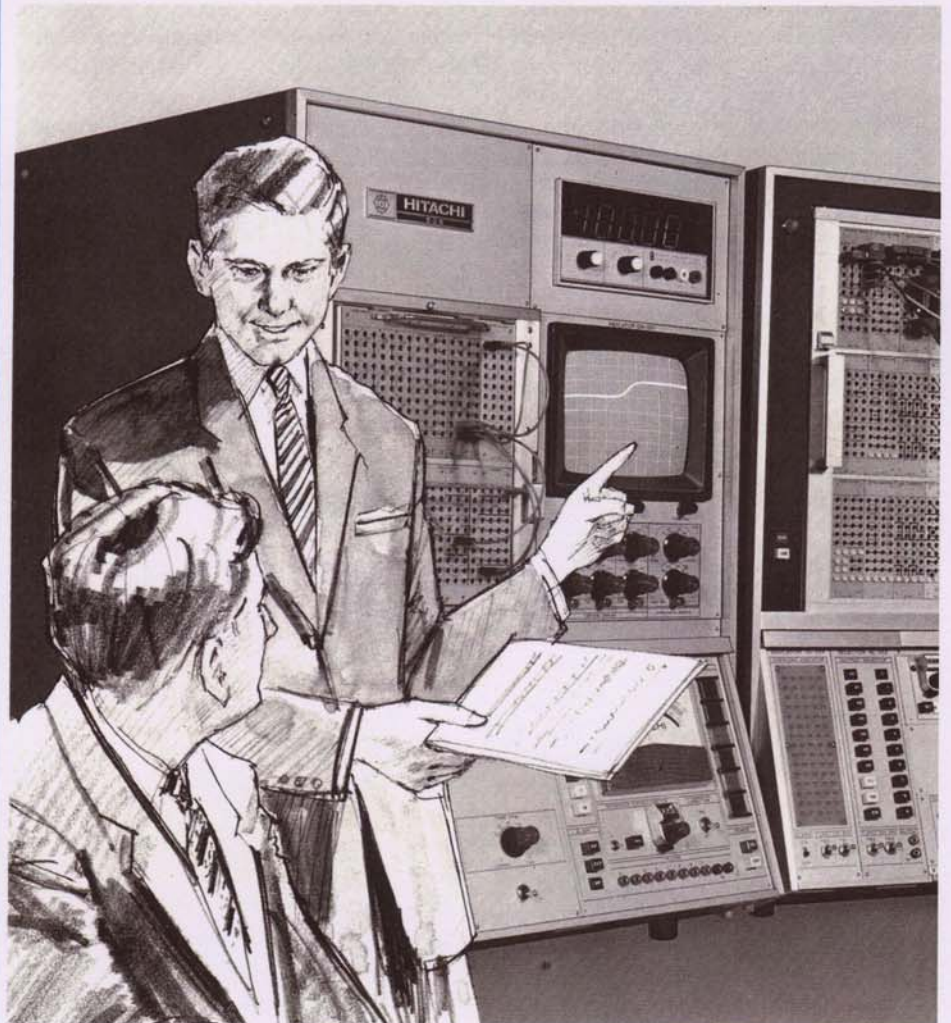

10 HYBRID ORIENTATION

Hitachi 505E is a well-designed, hybrid oriented computer; especially, offering facilities by built-in digital logic package and further hybrid capability presented by expandability of servo-set system.

The digital logic package includes Flip-flops, AND gates with inverters, Decimal counters, and Hitachi's unique Ring counter which may be programmed as a shift register, a program

controller, a general purpose decimal counter, and so on. It also terminates mode control of integrators, console mode control of integrators, console mode control inputs and outputs, clock interval timers, A-D trunks, general purpose indicators, and so on.

The maximum quantity of servo-set potentiometers when fully expanded is 72 in addition to 36 manual potentiometers. Servopot groups located directly behind the patch panel reduce phase error during high-speed repetitive operation. The servo-set control

structure is fully prewired to expand the computer to a complete integrated hybrid system. A HYBRID switch on the servo-set control panel may accept control signals for automatic amplifier readout, automatic addressing, and setting of servo-set potentiometers from the interface. Further, maximum 8ch A-D converters, 8ch D-A converters, 6ch Co signals, 6ch Ci signals, Program interrupts, and Mode Control Lines are offered by an extensive hybrid system with a general purpose digital computer.

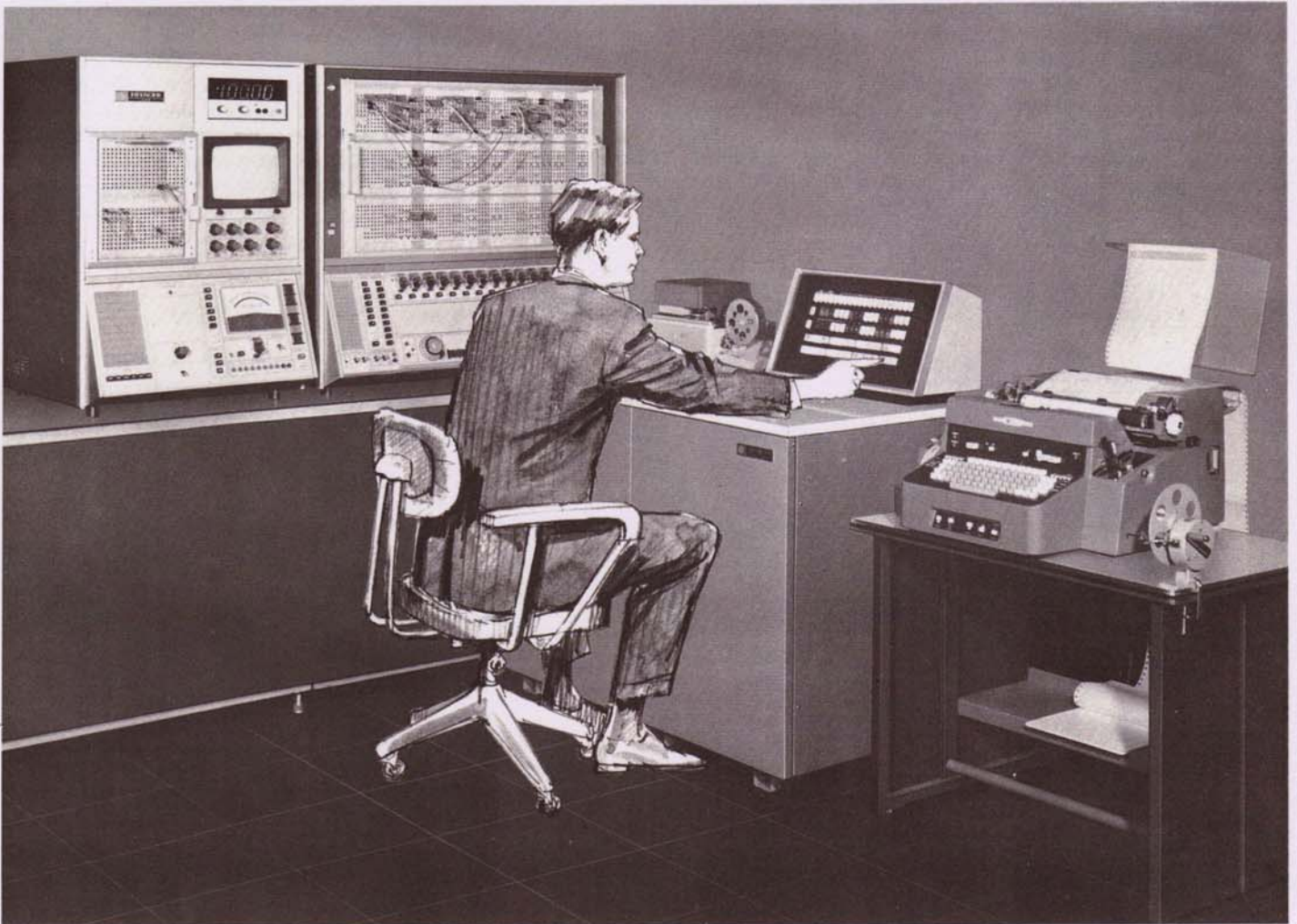

2 TIMER PANEL, TM-251:

Mounts individual coarse and fine time period adjustments for the 3-channel monostable timer. It provides 3 independent variable time for 3-mode repetitive operation. The adjustable time range is from 1 msec. to 10 sec., each with a 4-step multiplier. The panel has control push buttons for RUN, STOP and CLEAR, and has input/output terminations both on the analog and the logic patch panel. The timer, therefore, may be driven by a logical signal or may generate a logical signal.

When the timer is being cleared, all of the three timers generate a logic ZERO (0 volts). When the timer is in operation, three individual timers generate a logic ONE (+6V) in turn. The operation continues until the STOP button is pushed or when the STOP input is driven from a logic ZERO to a logic ONE.

In fact, the 3-mode repetitive operation not only merely provides a rapid display of solutions, it also aids precise measurement with less components, especially in optimization problems.

TIMER PANEL, TM-253, is available as an alternative unit. It controls only COMPUTE time at 2-mode repetitive operation (RESET \leftrightarrow COMPUTE) The time range is ten steps of 10ms, 20ms, 50ms, 100ms, 200ms, 500ms, 1s, 2s, 5s, and 10s.

3 CONTROL PANEL, CT-251:

Contains a volt meter, self-lighting mod push buttons for RESET, COMPUTE, HOLD POT-SET, ALL-RESET, and REP-OP, self lighting power ON-OFF buttons, meter range buttons, slave control buttons, a reference potentiometer with a null button and a reference voltage interchange switch, a console time scale interchange switch, and general purpose trunk terminations. Circuit principle of the three modes (RESET, COMPUTE, and HOLD) is based on EMC, but it also control EMC integrators with no wiring modification

1 LOGIC CONTROL PANEL, CT-252:

Provides state indicating lamps of decimal counters, a ring counter, flip-flops, and general purpose plus control push buttons for the ring counter and the digital logic. The control push buttons of the RC group may SHIFT or STOP or CLEAR the state of the ring counter which is essentially designed to be used as a general-purpose program controller, a shift register, a skip register, and a counter.

Other push buttons of the LOGIC group may control the mode of the entire digital logic components; e.i., RUN or STOP or CLEAR all of counters, flip-flops, and digital clocks.

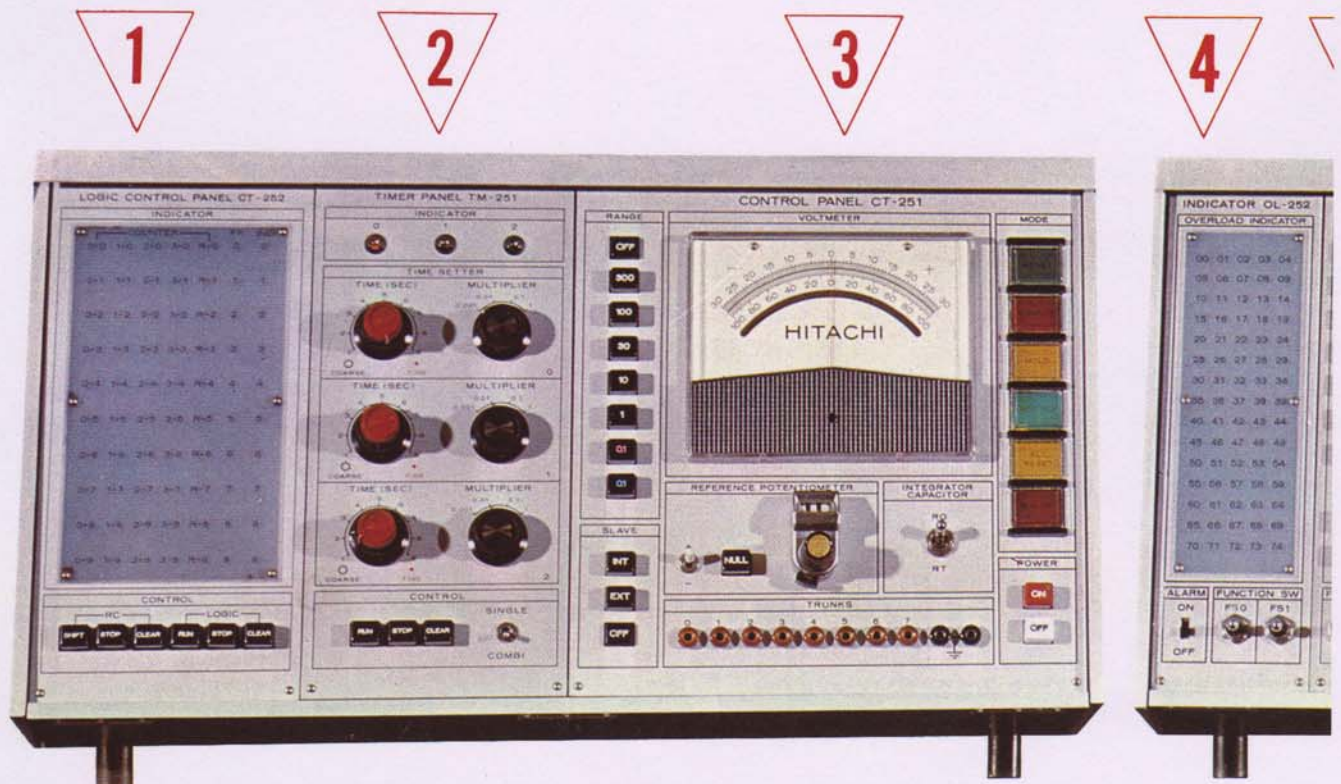

CONVENIENCE IN OPERATION

4 OVERLOAD INDICATOR, OL-252:

Provides overload indicating lamps of operational amplifiers (numbered 00 to 61), status indicating lamps of comparator amplifiers (numbered 62 to 69), overload indicating lamps of reference voltages (numbered 73 and 74), two single-pole, double-throw function switches, plus an audio alarm ON-OFF switch. If the audio alarm (designed to make a mild sound) is not required, the switch may be turned off. The audio alarm system may also be used for general purpose, and an audio alarm input termination is available on the analog patch panel.

5 OUTPUT SELECTOR, SL-252:

Provides push buttons for output selections, two double-pole, double-throw function switches, and an output terminal. The panel may select 62 operational amplifiers, 8 comparators, reference voltages, and another output selector mountable on the slaved analog console.

Alternative output selector, SL-252S, may additionally select 36 servo potentiometers. Potentiometer outputs are not selected by this panel because a SET push button distributed to each potentiometer performs output selection.

6 MANUAL POTENTIOMETER PANELS, PT-251:

Each panel, PT-251, contains 18 potentiometers. Each one third of them (6 pots), terminated to the potentiometer patch unit PT-151.3 out of 18 potentiometers, is the ungrounded type.

Each potentiometer is individually provided with a SET push button which is used for output selection. If two or more SET push buttons are simultaneously depressed, the potentiometer with the smaller number has the priority of being selected. A lamp above the potentiometer comes on when the SET push button is operated. The maximum quantity of potentiometers mountable in one analog console is 54.

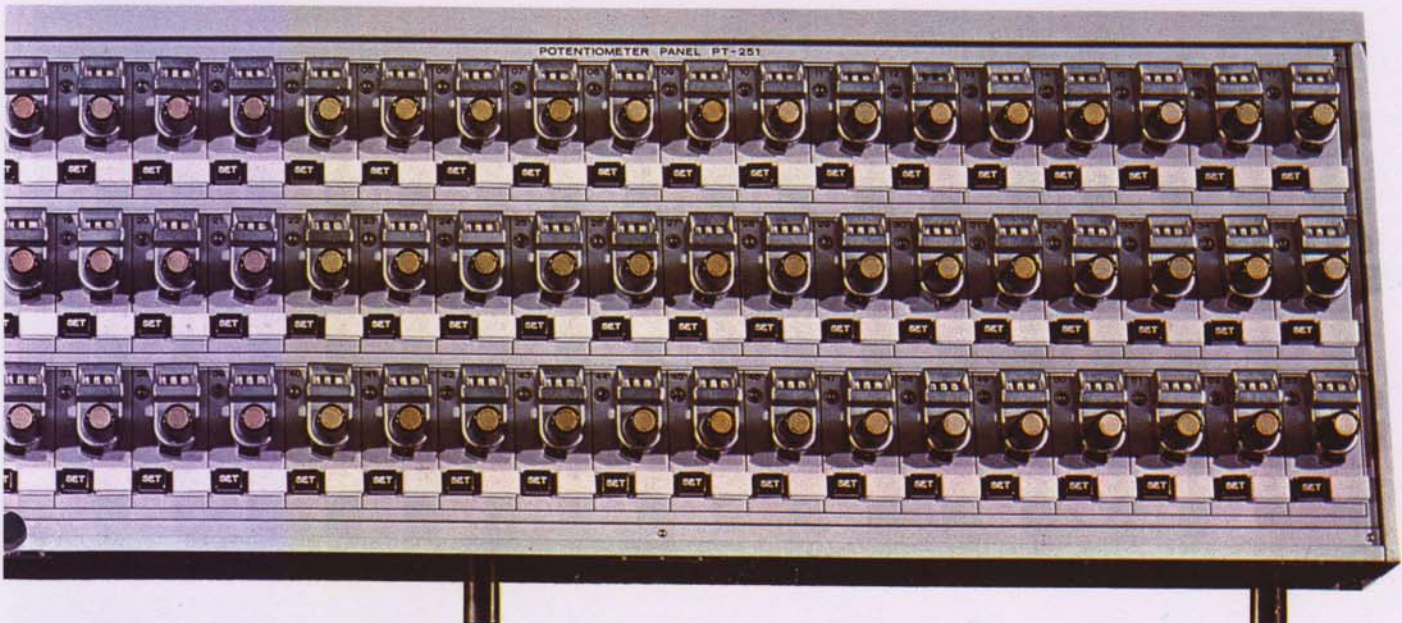

CONVENIENCE IN MAINTENANCE

The Hitachi 505E, is very carefully designed from the viewpoint of maintenance. Easily observable control circuits and printed boards without removing appropriate panels from the console aid the maintenance staff to adjust the machine fast and easily. In addition, Hitachi provides a complete interchangeability list of semiconductors, and immediate delivery of spare parts on urgent requirement, even down to a single screw. More important, complete documentation is available of which detailed circuit diagrams, for instance, give the maintenance staff point-by-point voltage and waveform information throughout the computer. Hitachi is sincerely proud of the simplified maintenance procedures for which the Hitachi 505E is particularly designed.

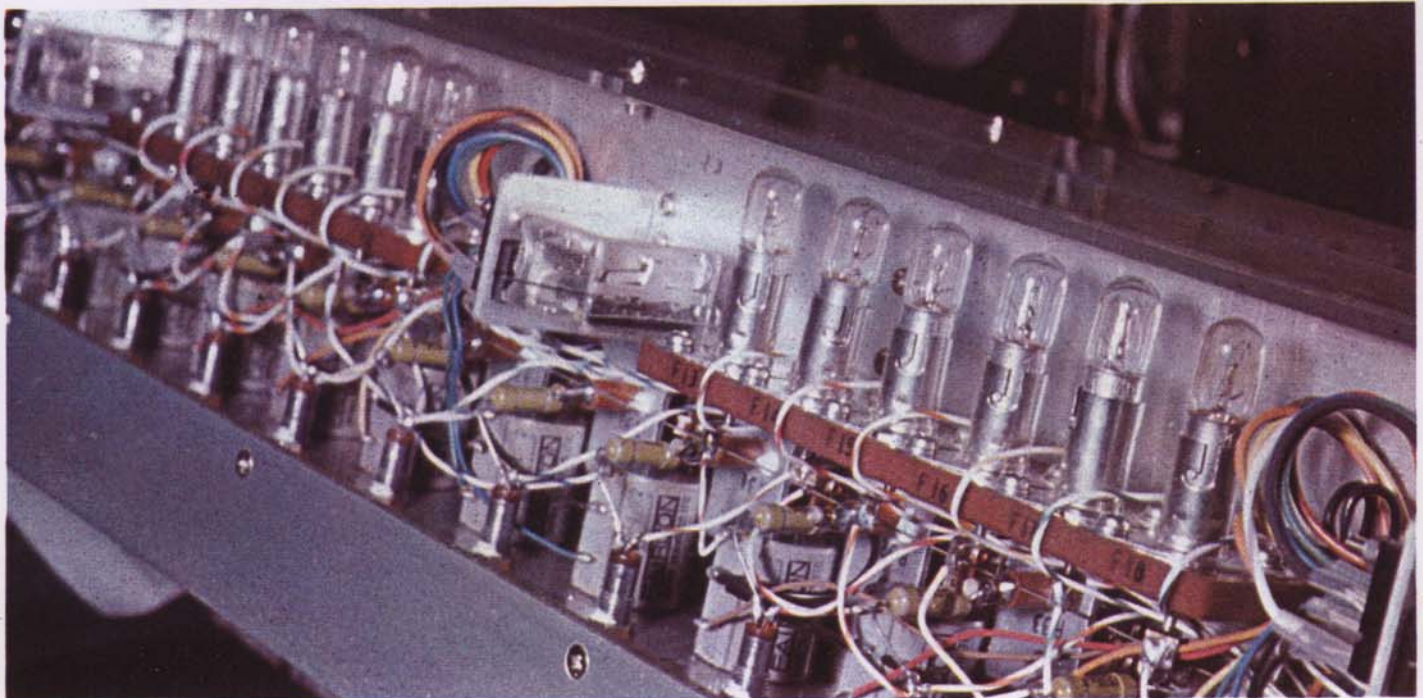
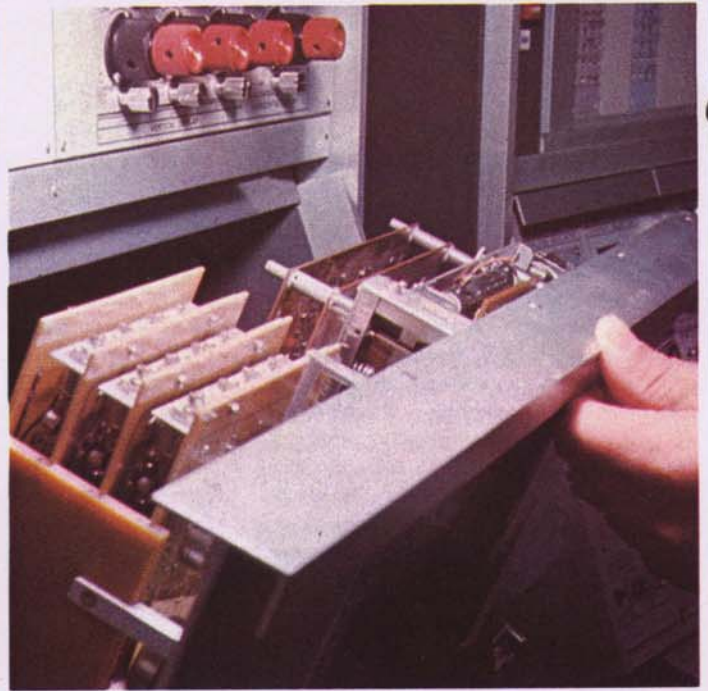

DESCRIPTION OF ANALOG COMPONENTS

OPERATIONAL AMPLIFIERS

Dual Amplifier Type DA-151A

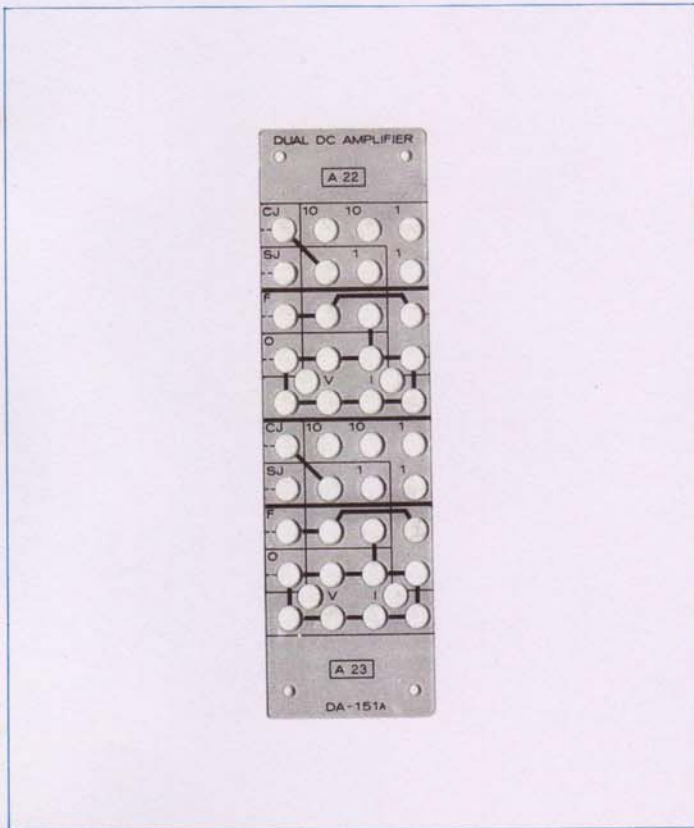

Featuring all-silicon transistors including a FET chopper results in a minimum temperature coefficient to reduce maintenance and improve long-term reliability. Among 100V desk-top analog computers, Hitachi 505E operational amplifiers have exceptionally high-quality static and dynamic performance, including open loop d-c gain exceeding a 6×10^7 phase shift error less than 0.1 degrees at 1 KHz. 50 KHz bandwidth at full amplitude (200 Vp-p). MTBF exceeding 100,000 hours.

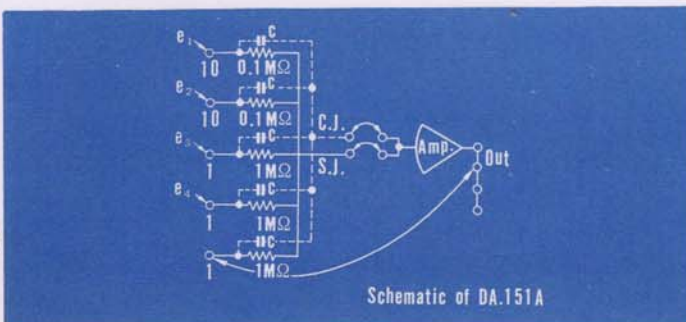

Quad Amplifier Type DA-153

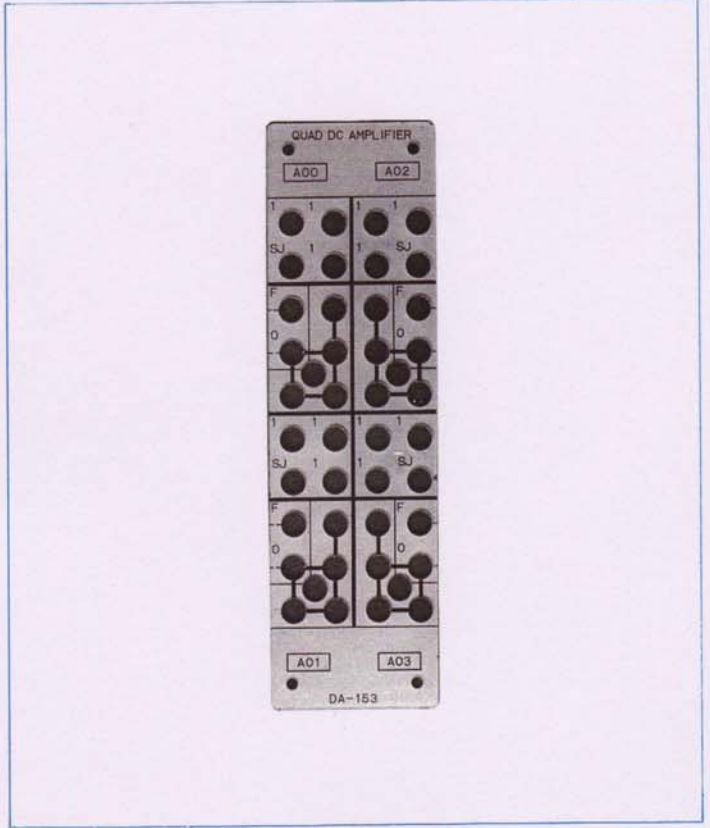

One of the special features available only in the Hitachi 505E operational amplifiers is the current balance system that makes it possible to minimize integrator drift down to $10 \mu\text{V}/\text{sec.}$, although the standard specification of integrator drift described in this brochure is $100 \mu\text{V}/\text{sec.}$ maximum, measured at the network of which the amplifier current balance system is not adjusted. (Available only in DA-151A.) The pot-set gain of the amplifier being 100 and the minimum voltage range of meter 100 mV, the amplifier output is observable equivalently over a 1mV F.S. meter range. The output current limit circuit provides complete protection against damage, even though the output is connected to any voltage on the board for many hours.

The resistor networks in the amplifier unit, separated from the amplifier circuits, require only one bottle plug connection since they are used as a summing amplifier, or they may be available for other purposes if they are not being used. These two units are interchangeable with each other.

DESCRIPTION OF ANALOG COMPONENTS

INTEGRATOR NETWORKS

Both integrator networks of RMC (IN-151) and EMC (IN-153) are available, usually combined with DA-151A for normal operation. The marking of IN-153 (EMC) is identical with that of IN-151 (RMC), although it is not illustrated here. These two types of units are completely interchangeable with each other without console modification, because console control structure for the mode is previously designed based upon EMC. These two types, therefore, may coexist on the same patch panel, so that the programmer can economically select and/or combine integrators between two types, depending on solution requirements.

Each integrator unit consists of two integrator networks. On the patch panel, it terminates patchable EMC or RMC, IC input, patchable time scale, console mode outputs, D-A trunks, and other indispensable lines, most of which patchings are achieved by bottle plug connections.

Simply by changing the bottle plug position, the integrator mode can be directly controlled from the digital logic patch panel without using a voltage level converter or a buffer amplifier.

Other than a patchable time scale, console time scale interchangeability is also provided; that is, the ability to select two time scales in any combination among 1s, 0.1s, 0.01s, and 0.001s.

The integrator network may be also patched as an electronic switch (if EMC) or a track/store unit. Feedback capacitors wired in the unit may be used as free capacitors if the integrator network is not in use.

Dual Integrater Type IN-151 (RMC) Type IN-153 (EMC)

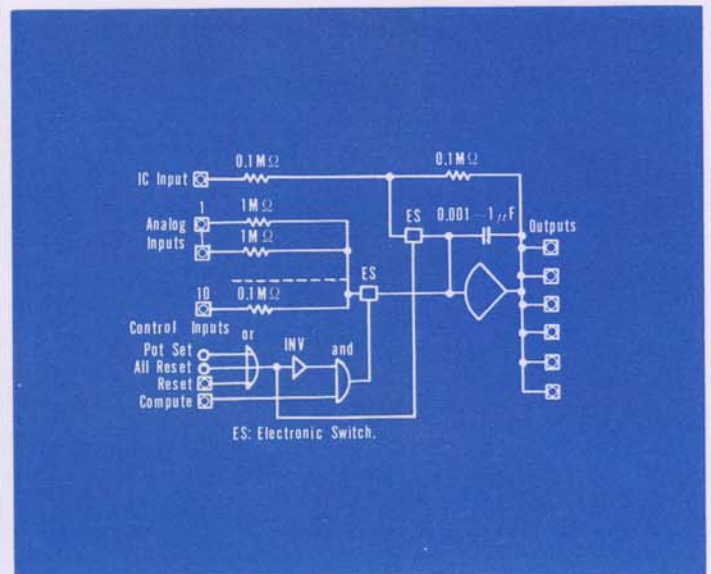
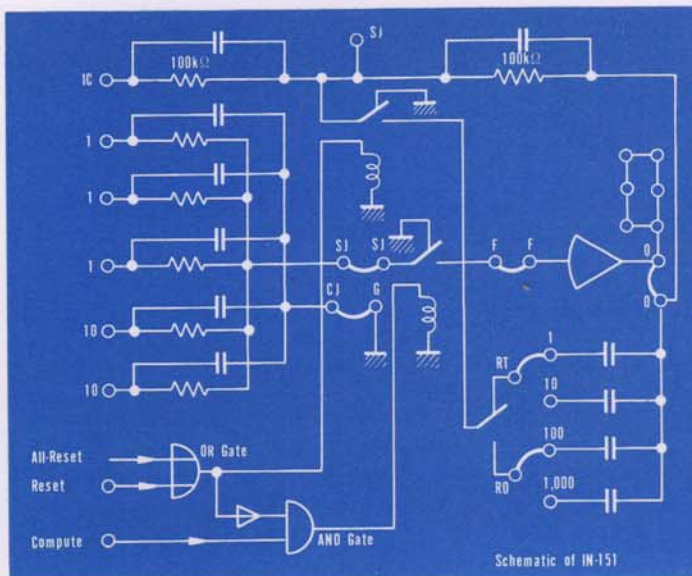
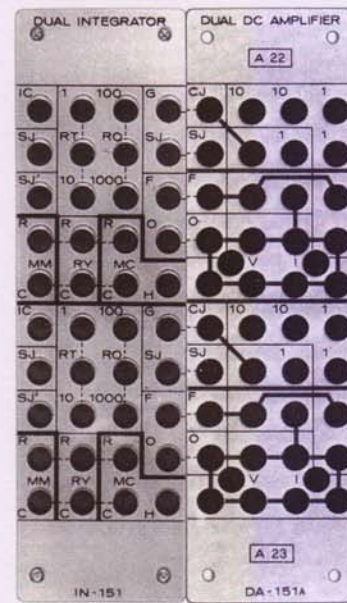

Potentiometer

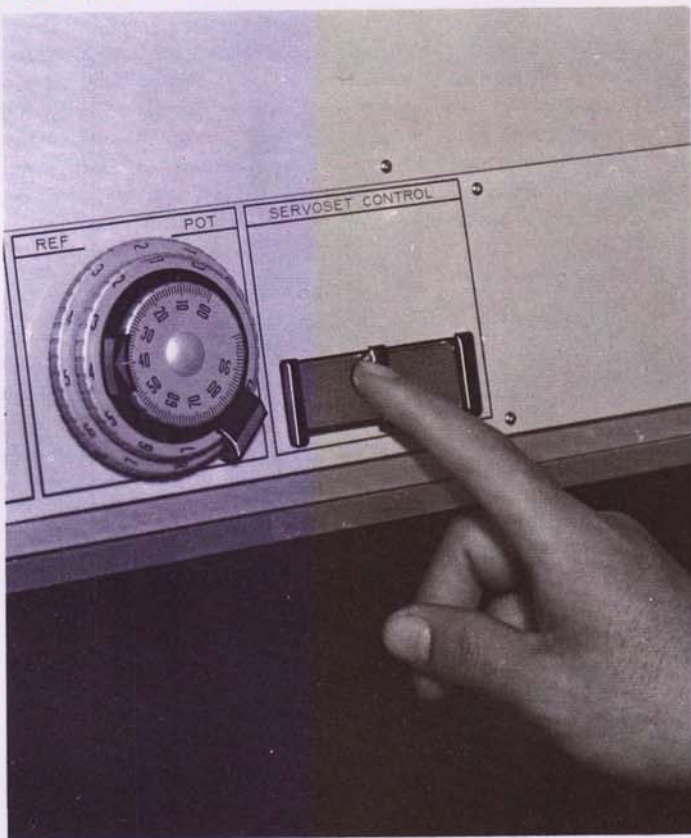

Type PT-251 (Potentiometer)

Type PT-151 (Potentiometer Patch Unit)

Type SP-151 (Servo-Potentiometer Unit)

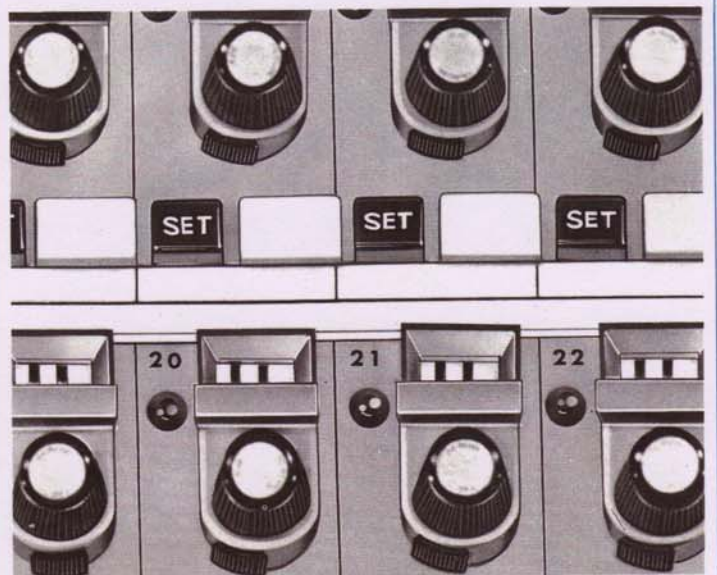
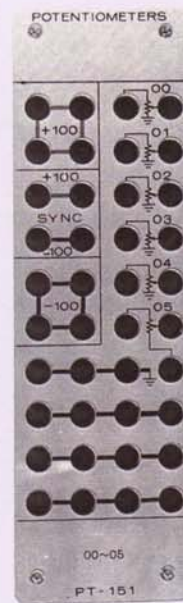

DESCRIPTION OF COMPUTING COMPONENTS

Multipliers

Hitachi 505 electronic multipliers consist of two square function generator cards with which three operational amplifiers are combined for multiplication, division, and squaring. Silicon transistors and ultrahigh-speed diodes of which response time is only 4 nsec. are used throughout to minimize drift and to ensure maintenance-free life. Temperature coefficient of the diodes is compensated to obtain stable operational performance.

For easy patching, the multiplier can be converted to a divider or vice versa simply by replacing a bottle plug at the terminations indicated.

The multiplier, Type EM-153, is designed essentially for high-accuracy operation at low-output noise. Provided with four inputs ($\pm X$, $\pm Y$), it does not always require three operational amplifiers, should signals $\pm X$ or $\pm Y$ be available elsewhere on the patch panel. Both types employ particular formula to product multiplication. The equation is:

$$XY = \frac{1}{2} \left\{ \frac{1}{2} (X+Y-1)^2 - \frac{1}{2} (X-Y-1)^2 \right\} + Y$$

In fact, the function $\frac{1}{2} (x-1)^2$, $-1 \leq x \leq 1$

requires less break points to perform operation in similar accuracy than does the function, x^2 , $-1 \leq x \leq 1$.

Major specifications for both types are as follows ;

- Accuracy : $\pm 0.1\%$ ($\pm 100\text{mV}$), Typical (EM-151)
 $\pm 0.02\%$ ($\pm 50\text{mV}$), Typical (EM-153)
- Bandwidth : 80 KHz (EM-151), 100 KHz (EM-153)
 at small input.

Type EM-151

Type EM-153 (High Accuracy)

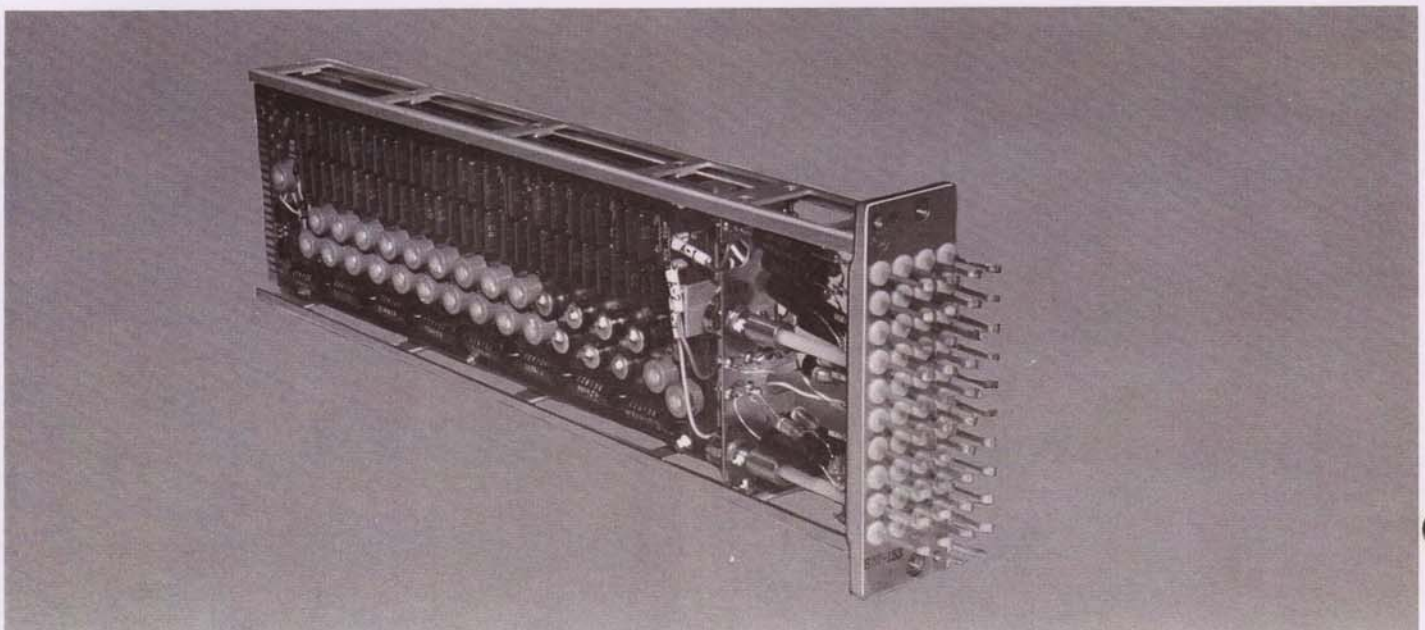
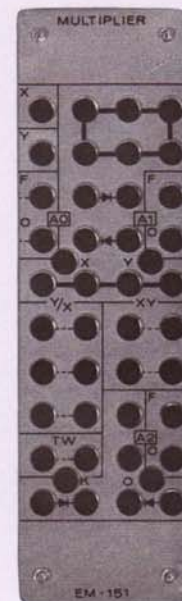

- Type FG-151 (Patch Unit)
- FG-051A (Setup Unit Positive)
- FG-051B (Setup Unit Negative)
- FG-152 (Patch Unit)
- FG-052 (Setup Unit)

VARIABLE DIODE FUNCTION GENERATORS

VDFG, FG-151 includes Patch Unit, FG-151, Setup Unit, FG-051 A for positive input, and FG-051B for negative input. The FG-151 may be used as two function generators or as one slave function generator by simply inserting or removing a bottle plug at the terminations indicated. Each setup unit consists of ten fixed break points, their maximum slope $\pm 5V/V$. Four operational amplifiers are combined with the FG-151 for dual-function generation, whereas two operational amplifiers are combined for 20 break points from $-100V$ to $+100V$ function generation.

VDFG, FG-152 includes Patch Unit, FG-151, two Setup Units, FG-052. The FG-052 contains ten fixed break points and covers the entire input range from $-100V$ to $+100V$.

Maximum slope is also $\pm 5V/V$, but two FG-052's cannot be connected with each other.

Neither type requires reference input voltage at setup procedure. Circuit principle of each setup unit is to duplicate various heights of triangular units to facilitate setting procedure and to minimize setting time. The programmer does not have to remember how many points have been set because the unit self-memorizes the fact mechanically.

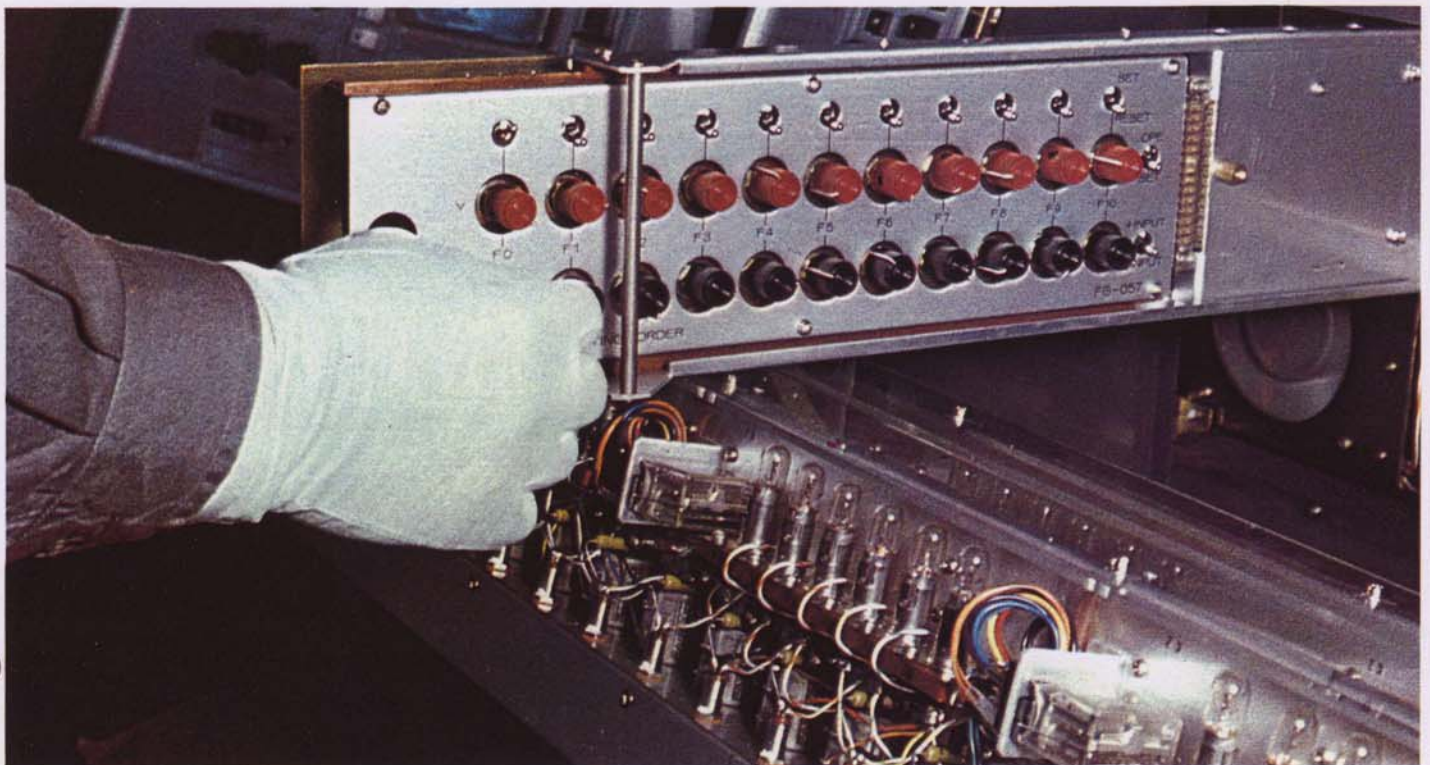
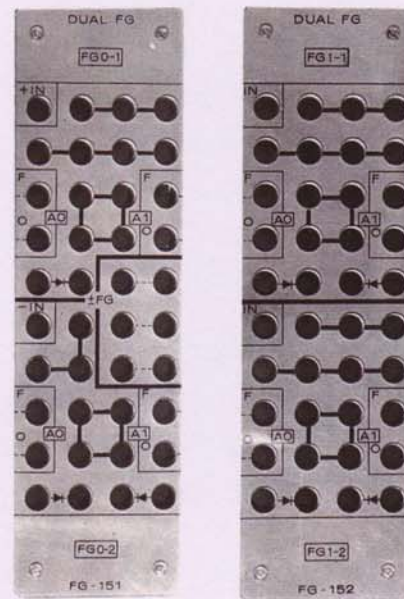

**Type FG-157 (Patch Unit)
FG-057 (Setup Unit)**

This VDFG consists of Patch Unit, Type FG-157, and Setup Unit, Type FG-057 which contain ten variable break points. Each break point can be assigned anywhere between +100V and -100V. One of the exceptionally remarkable features of this VDFG is its capability of having $\pm 1000V/V$ SLOPE generated; i.e. the maximum slope is practically infinite. Because of this, FG-157 requires five operational amplifiers for function generation. Another remarkable characteristic of this VDFG is the fact that X and Y coefficients can be set independently from each other; i.e. the programmer can perform entire X setting first, and, then set the entire Y coefficients. In most conventional VDFG's, there is always some sort of mutual effect between the X and Y coefficient, and the programmer experiences difficulties in adjustment. The setting method of FG-157, however, has eliminated many troublesome setting procedures and provided the programmer with the easiest computer operation. Acceptable quantity of the FG-157 is one per each console.

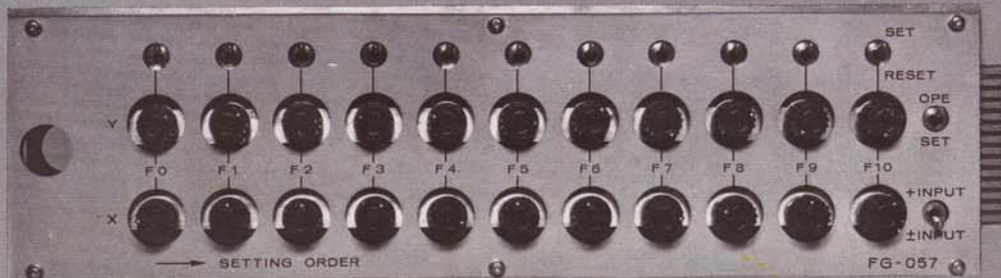
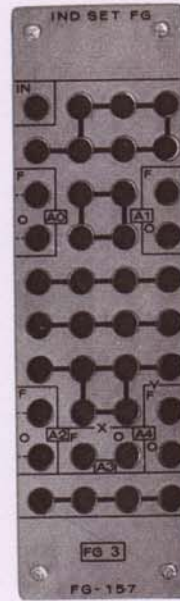

FIXED DIODE FUNCTION GENERATORS

Trigonometric Function Generator, Type FG-153, has a single trigonometric function circuit; the FG-153A has two such circuits, each requiring one operational amplifier for function generation. Input range is selectable between $\pm\pi$ and $\pm\pi/2$ by changing the bottle plug connection at the terminations illustrated. An inverted function can be obtained in the same way.

Metal-filmed resistors and temperature-compensated diodes are used throughout to obtain reliable, stable operational performance.

Square Function Generator, Type FG-154, has two square function generator circuits; the FG-154A has four such circuits, each requiring one operational amplifier for function generation. An inverted function can be obtained by changing the bottle plug connection on the patch panel. High-speed diodes having 4nsec response time and metal-filmed resistors are the main factor in obtaining stable, reliable unit performance.

Logarithmic Function Generator, Type FG-155, has two logarithmic function generator circuits; the FG-155A has four such circuits, each requiring one operational amplifier for operation. Half of those circuits are for negative input, the other half are for positive. Inverse function can be performed by changing a bottle plug connection on the patch panel. Also high-speed diodes and metal-filmed resistors are used throughout.

RELAY COMPARATORS

Two different types are available, the major specific difference being 5 msec. at CP-151 and 0.5 msec. at CP-152. Each unit consists of four comparator amplifiers and four double-pole, double-throw relays. The comparator amplifiers are separated from relay networks, and the electronic output—capable of directly driving integrators or console modes—is available on the patch panel. Should the relay be driven by the comparator amplifier, a bottle plug connection may be made between the electronic and the coil input of the relay. Hysteresis characteristics are applied to the amplifier circuit to reject input noises; therefore, sensitivity is kept rather low. Silicon transistors are used throughout. Output voltage level of the amplifier is identical with that of the logic patch board. Response time of the electronic output is 10 μ s.

Type FG-153, FG-153A
(Trigonometric Function Generator)

Type FG-154, FG-154A
(Square Function Generator)

Type FG-155, FG-155A
(Logarithmic Function Generator)

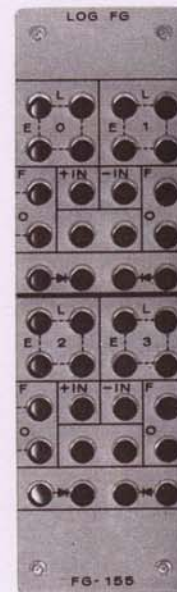

Type CP-151 (Comparator)
CP-152 (Comparator)
(High Speed)



DESCRIPTION OF COMPUTING COMPONENTS

ELECTRONIC SWITCH

The unit consists of four comparator amplifiers and four electronic switches. The comparator amplifiers in this unit are practically identical with those of CP-151 and CP-152. Response time of the electronic switch is less than $1 \mu s$. Total resistance accuracy of the switch is $100 K \pm 0.2\%$ including FET internal impedance. The equivalent open resistance is approximately $10^{10} \Omega$.

Type CP-153

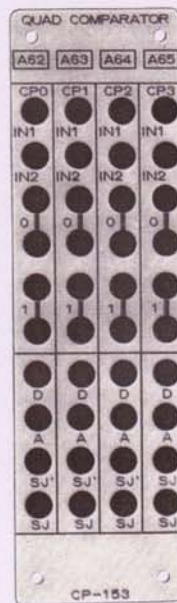

AUTOMATIC OPERATOR UNIT

The AO-151 essentially contains one multiplier and one integrator (except an operational amplifier), plus necessary wiring to solve boundary problems or other iterative techniques. The parts mentioned are combined into prewired blocks so that panel wiring may be reduced; consequently, programming for iterative computation is simplified by using this unit.

Type AO-151

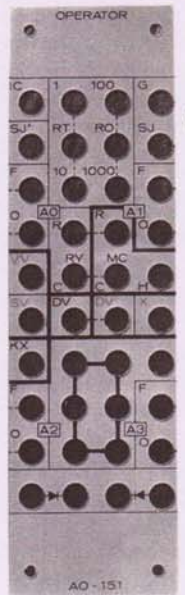

TIME DELAY UNIT

The electronic transfer delay component is based upon Pade second order approximated equation. The TD-151 requires two operational amplifiers for operation. Two TD-151's can be slaved to construct a fourth order transfer delay. The unit is accepted to the position where integrators are mounted, and the time scale is interchangeable or patchable in the same manner as integrators. Delay time range is from 0.0001 sec. to 10 sec.

Type TD-151



TRUNK UNIT

This unit is used to transfer various signals to and from external equipment and/or a slaved console, 40 general-purpose trunk lines are available, terminated to the connector located on the rear side of the console.

Type TR-151

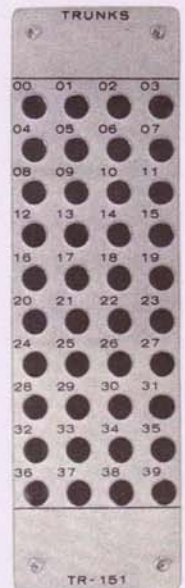

DISPLAY DEVICE

OSCILLOSCOPE

Type OS-252

For convenience in observing solutions in high-speed repetitive operation, a special purpose built-in oscilloscope is available. Provided with one horizontal input and four vertical inputs, four waveforms can be simultaneously displayed. The cathode ray tube used in this oscilloscope has a rectangular 230-mm. (9-inch) scope face which permits easy observation. In addition, an electronic scale (11 lines×11 lines) is displayed to enable accurate measurement of the problem solution due to parallax and scope distortion (usually an unavoidable problem on an oscilloscope with a fixed scale) being completely compensated.

The time axis generator in the oscilloscope can be used as a timer which controls the interval of repetitive operation when the REP-OP button on the control panel (CT-251) is pushed. The time base is discretely changed.

Excluding the cathode ray tube and the rectifier, the circuit is composed entirely of semiconductors with printed wiring.

Brief Specifications:

Range Vertical	200V, 100V, 50V, 20V F.S.
Range Horizontal	
Time base	2s, 1s, 500ms, 200ms, 100ms, 50ms, 20ms and 10ms.
Voltage base	200V, 100V, 50V, 20V, F.S.
Bandwidth	10 KHz
Brightness Modulation	Yes.

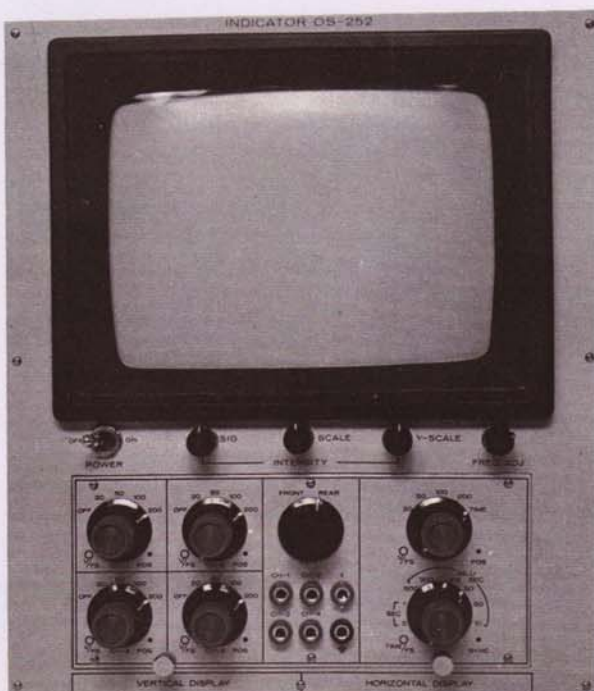

DIGITAL LOGIC PACKAGE



**Counter Unit
CU-151A**

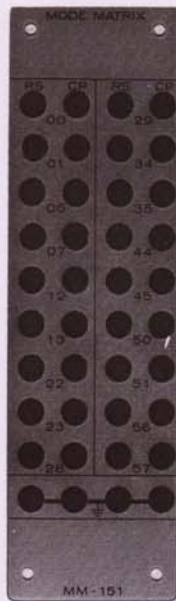

**Mode Matrix
MM-151**



**Flip-Flop Unit
FF-151A**

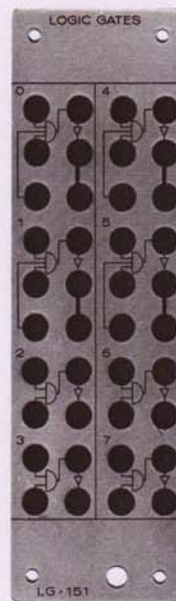

**Logic Gate Unit
LG-151A**

The digital logic package (CL-252) is installed in the control console (CS-505B) with the removable logic problem board (PP-505D), the logic power supply (PS-053), the logic control panel (CT-252), and the unit mount (UM-252). The various types of digital logic components installed in this package are so designed to provide wide-range logic control capability for analog program networks with minimum programing time and with minimum programing preconsideration. For instance, voltage level converters which are supposed to be installed somewhere between the analog and the logic patch panel are omitted since each logic component is provided with large-output current capability.

All digital logic outputs are identical with outputs of the timer, the comparator, and the console mode. A logic ONE is +6V or greater and a logic ZERO is approximately zero volts, with which the integrator mode is also controlled.

The Flip-Flop Unit, FF-151A, contains 5 RST flip-flops with a state indicating lamp individually provided. All flip-flops may be simultaneously reset by one signal or by a push button.

The Logic Gate Unit, LG-151A, contains four 2 input AND gates and four 3 input AND gates with an inverter individually provided. Any logic gate may be formed by combining these AND gates.

The Counter Unit, CU-151A, contains two decimal counters with ten indicating lamps each. Each counter is provided with RUN,

CLR (Clear) inputs, and CR (Carry up) output. Only one output out of ten is a logic ONE, the other nine outputs logic ZERO, the lamp group so indicating. Driving the RUN terminal from a logic ZERO TO ONE shifts the counter by one step. If a logic ONE is supplied to the CLR terminal, the counter will be cleared and a logic ONE appears at the 0 output, leaving the remaining nine outputs as a logic ZERO.

The CR output provides a logic ONE impulse as soon as the counter is shifted from the 9 output to the 0 output: This impulse may be used for driving another decimal counter to make a multidigit decimal figure.

The Mode Matrix, MM-151A, contains 18ch integrator mode driving inputs. Driving the RS terminal numbered 0 from a logic ZERO to ONE causes the integrator 0 to be RESET, if the control input terminations are connected to the MM outputs (See Page 14). Driving the CP terminal will cause the integrator to COMPUTE. If both terminals are fed with a logic ZERO or are open, the integrator will become HOLD. The MM-151A may be used as a general purpose trunk.

The Ring Counter Unit, RC-151 is double paneled, and includes one ring counter, timer input and output terminations, logic mode input and output terminations, analog console mode input terminations, and ten general-purpose indicating lamp terminations.

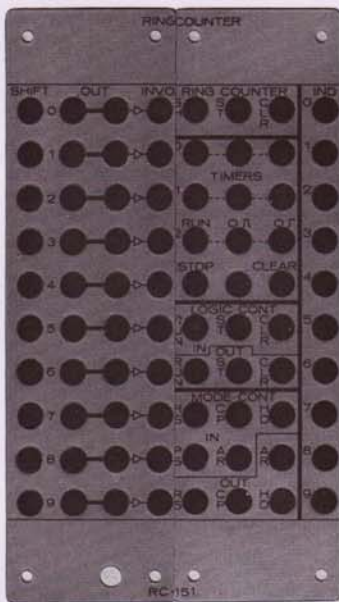

**Ring Counter Unit
RC-151A**

The operating principle of the ring counter is identical with that of the CU-151A, except that the ring counter is provided with an individual SHIFT input and an inverter at each position. The ring counter may also be controlled by the push-button group located on the logic control panel (CT-252). (See Page 10)

The counter group, including the CU-151A, may be used as a shift resistor or as a timer with 0.1 msec. resolution.

The Trunk Unit, TR-153A, contains 8ch A-D trunks and one digital



**Trunk Unit
TR-153A**

clock set. A-D trunks include a wave form converter to sharpen the comparator output sufficiently to drive the comparator output sufficientl to drive the logic components.

The digitaly clock clock contains a 100 KHz pulse oscillator divided down to 0.1Hz and providing 10KHz, 100Hz, and 10 Hz outputs. The clock may be fed to the counter group to form a multidigit precision timer (5 digits maximum).

ACCESSORIES

To facilitate operation of the Hitachi 505 analog computer system, the following accessories are provided:

a) Patching Kit, PK-505

One patching kit set, PK-505, containing the following various-sized shielded patch cords and bottle plugs.

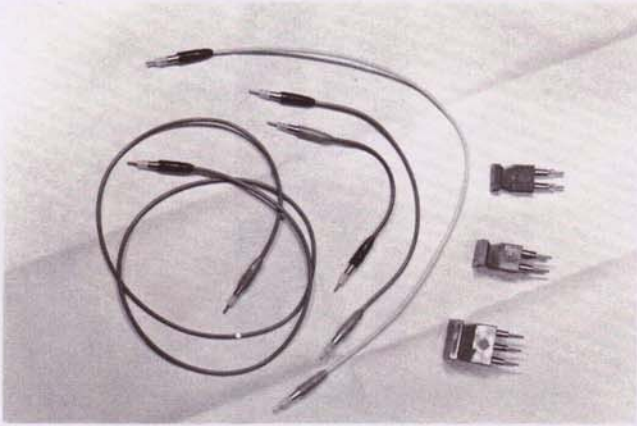

Shielded Patch Cords:

PC-012 (10cm, brown)	20 ea.
PC-022 (20cm, red)	40 ea.
PC-042 (40cm, yellow)	20 ea.
PC-062 (60cm, green)	10 ea.
PC-082 (80cm, violet)	5 ea.
PC-102 (100cm, grey)	5 ea.

Shielded Bottle Plugs:

BP-021 (2 pins)	25 ea.
BP-041 (4 pins)	20 ea.
BP-061 (6 pins)	5 ea.

b) Potentiometer Cover, PC-001

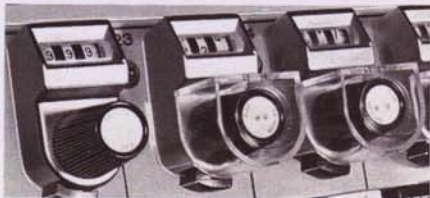

Although each potentiometer is provided with a dial lock, misshifting of set valves still occurs.

To avoid such mishaps, a cover is provided.

c) Magnetic Memo Plate, PN-001



The plate with a surface for easy writing and erasing is sometimes needed to memorize what purpose the potentiometer is being used for and what the value is.

d) Function Generator Setting Unit, FU-051

This is an extender of the VDFG setup unit.



e) Test Unit, MU-051

Provided for conducting maintenance on the computer. A component check can be performed under operating conditions by this unit.



f) Accessory Box, AB-505

Compactly accommodates patch kits and patch boards. A maximum of 3 patch boards can be stored in the box under a patched condition.

g) Service Handle

Employed to remove components from the patch bay; also protects pins while the component is removed.

	505-10		505-30		505-60		505-120	
	Units	Compt.	Units	Compt.	Units	Compt.	Units	Compt.

COMPUTING COMPONENTS

WIRED CONSOLE including complete Control Panel, Output Selector, Overload Indicator, Computer power supply, and $\pm 100V$ reference system.	1		1		1		1*	
Dual DC Amplifier, DA-151A	5	10	15	30	10	20	20	40
Quad DC Amplifier, DA-153					10	40	20	80
Dual Integrator Network, IN-151	2	4	6	12	8	16	16	32
Dual EMC Integrator Network, IN-153								
Manual Potentiometer Panel, PT-251	1	18	2	36	3	54	6	108
Potentiometer Patch Unit, PT-151	3		6		9		18	
Multiplier, EM-151			3	3	5	5	10	10
High-accuracy Multiplier, EM-153								
VDFG, FG-151 with Setup Unit FG-051A & FG-051B			1	2	2	4	4	8
VDFG, FG-152 with Two Set up Units FG-052					1	2	2	4
Trigonometric Function Generator, FG-153A								
Square Function Generator, FG-154A					1	4	1	4
Logarithmic Function Generator, FG-155A					1	4	1	4
VDFG, FG-157 with Set-up Unit FG-057								
Quad Comparator Amplifier/Relay, CP-151			1	4	1	4	2	8
Quad Comparator Amplifier/High-Speed Relay, CP-152								
Quad Comparator Amplifier/EMC Switch, CP-153								
Time Delay Unit, TD-151								
Free Diode/Resistor Unit, FD-151A	1		1		1		2	
Trunks, TR-151			1	40	1	40	2	80

HYBRID COMPONENTS AND CONTROLLERS

Servo Potentiometer Control Panel, SP-253								
Servo Potentiometer Patch Unit, SP-151								
Logic Cabinet with Power Supply and Control Panel								
Flip-Flop Unit, FF-151A								
Logic Gate Unit, LG-151A								
Counter Unit, CU-151A								
Mode Matrix, MM-151A								
Ring Counter Unit, RC-151A								
Trunk Unit, TR-153A								

DISPLAY EQUIPMENT

Digital Voltmeter			1		1		1	
Oscilloscope, OS-252			1		1		1	

ACCESSORIES

Prepatch Panel, PP-505	1		1		1		2	
Logic Prepatch Panel, PP-505D								
Patch Kit, PK-505	1		2		3		5	
Test Unit, MU-051	1		1		1		1	
Function Generator Setting Unit, FU-051			1		1		1	
Service Handle	1		1		1		1	

 **Hitachi, Ltd. Tokyo Japan**

Head Office: 4, 1-chome, Marunouchi, Chiyoda-ku, Tokyo 100
Tel. Tokyo (212) 1111 (80 lines)
Cable Address: "HITACHY" TOKYO
Codes: All Codes Used

Inquiries to:
Telecommunications Department
International Division
Nippon Bldg. No. 8, 2-chome, Ohtemachi
Chiyoda-ku, Tokyo
Tel. Tokyo (270) 2111
Cable Address: "HITACHY" TOKYO